

PLAN 1:50

- Limite minimale avec dalles antichocs
- - - Espace de chute

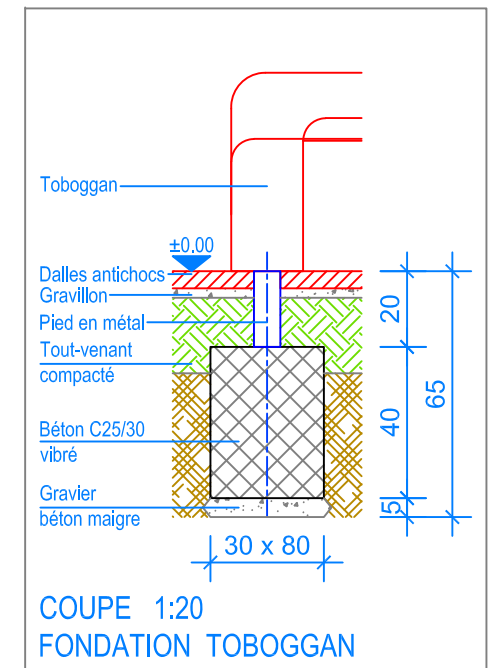
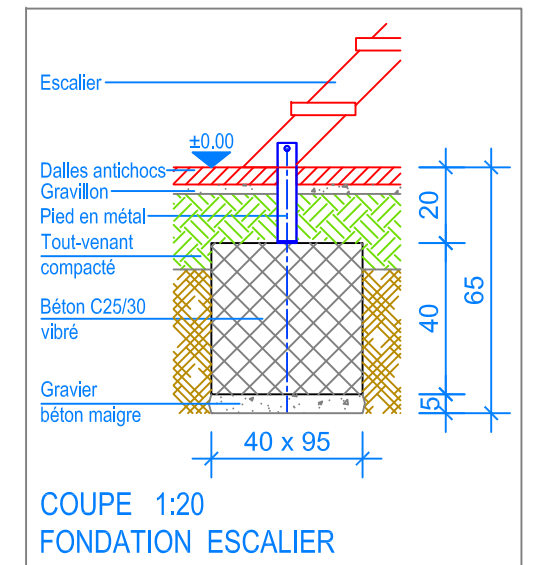
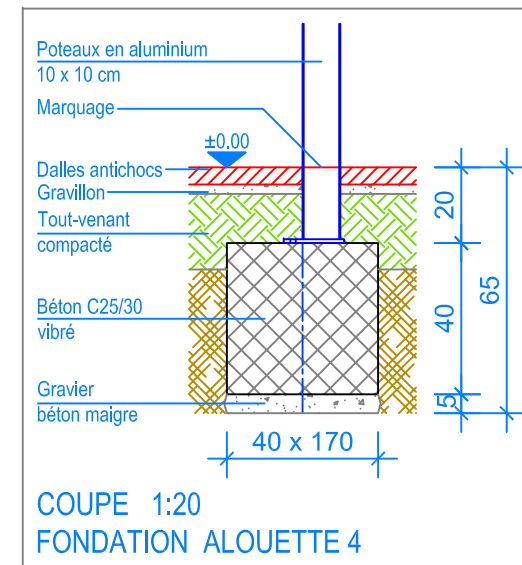

Fuchs Thun AG
 Tempelstrasse 11, CH-3608 Thun
 Tel. 033 334 30 00
 Internet: www.fuchsthun.ch
 E-Mail: info@fuchsthun.ch
 Conseil et vente Suisse romande
 Tél. 079 314 64 50

Objekt: Plan des fondations dalles antichocs:
 3.67.03 Alouette 4 - HP = + 140 cm

Dat.: 28.06.2013	Rev.: 23.01.2019 - MT	PLNr.: 3.67.03
Gez.: Silvia Meyer	Rev.: 03.04.2024 - MT	Mst.: 1:50 / 1:20